



Room thermostat

**TAT220/FC/SUPER**

Owner's manual and Technician settings

 **meitav-tec**

## Index

---

1. Owner's Manual.....	3-5
1.1 Turning the unit On or Off .....	3
1.2 Adjusting the set-point temperature .....	3
1.3 Selecting system mode .....	3
1.4 Selecting fan speed.....	3
1.5 Timer .....	4
1.6 Locked buttons display.....	4
1.7 Occupancy sensor display .....	4
2. Installation instructions .....	5
3. Wiring connections .....	5
4. DIP switch configuration .....	6
5. External temperature sensor connection (T1).....	6
6. Technician settings .....	7-8
Enter technician settings .....	7
6.1 Set point temperature limit for heat .....	7
6.2 Set point temperature limit for cool.....	7
6.3 Lock buttons .....	7
6.4 Offset for calibration of ambient temperature .....	7
6.5 Enable or disable the LCD backlight.....	7
6.6 Enable or disable Auto speed selection .....	7
6.7 Selecting On/Off or Start/Stop configuration.....	7
6.8 Fan on demand configuration (Auto fan) .....	8
6.9 Internal or External sensor .....	8
6.10 Occupancy sensor logic.....	8
6.11 Occupancy sensor polarity .....	8
6.12 Occupancy sensor off delay.....	8
6.13 Action when returning to occupied mode .....	8
6.14 Resolution of temperature display.....	8

## 1. Owner's Manual

---

### 1.1 Turning the unit On or Off

---

- Press the [On/Off] button to turn the unit On.  
The word "ON" will appear on display.
- Press the [On/Off] button again to turn the unit Off.  
The word "OFF" will appear on display.

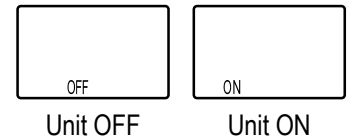

### 1.2 Adjusting the set-point temperature

---

- Press the [+] or [-] buttons – the set-point temperature will flash.
- Press the [+] or [-] again to adjust the set-point temperature.



Note: the temperature display can be changed by technician to set-point only,  
Please refer to DIP switch configuration.

### 1.3 Selecting system mode

---

- Press the [Mode] button to switch between system modes:



Notes:

- The ❄️ or 🌊 icons will flash with demand for cooling or heating.
- The selection of Auto mode is disabled by default and can be enabled by changing DIP switch S1 position to ON.

### 1.4 Selecting fan speed

---

- Press the [Fan] button to switch between fan speeds:

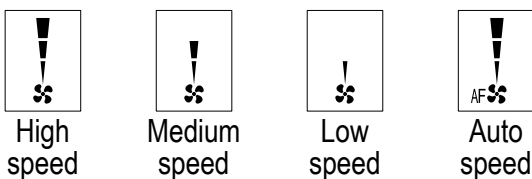

Notes:

- In "Auto speed" the letters "AF" and the active speed will appear on display.
- The selection of Auto speed can be disabled through technician settings.

## 1.5 Timer

---

The timer will switch the thermostat ON or OFF according to the current status.

If the thermostat is ON, the timer will switch it OFF.

If the thermostat is OFF, the timer will switch it ON.

- Press and hold the [On/Off] button for 5 seconds – the hours will appear on display.
- Use the [+] and [-] buttons to adjust the timer (range: 0-10 hours).
- Press the [Mode] button or wait 30 seconds to return to normal mode.

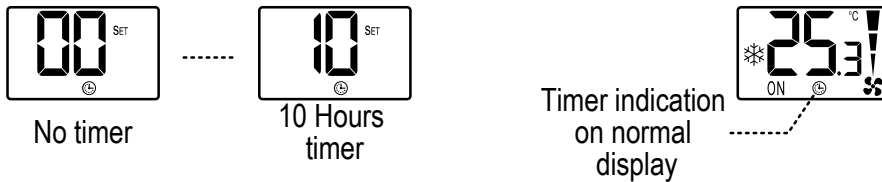

Notes:

- When active, the clock icon will appear on display.
- In order to cancel the timer, follow the steps above and set the hours to "00".
- In On/Off configuration, after an electrical blackout, the timer will start the counting from the beginning and the clock symbol will flash.
- In Start/Stop configuration, after an electrical blackout, the thermostat will remain off and the timer will be cancelled

## 1.6 Locked buttons display

---

When the thermostat buttons are locked (please refer to technician settings), on any attempt to press a locked button, the  icon will appear on display.

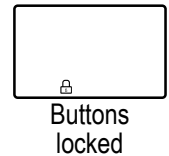

## 1.7 Occupancy sensor display

---

When the occupancy sensor is operated, and there is no movement detection in the room, after the preset delay, all the outputs will turn OFF and the "°C" icon will flash.

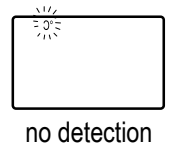

## 2. Installation instructions

The thermostat is designed for flush mounting in the room to be controlled.

It should be located where the occupant can easily read the LCD display and use the controls.

If the built in temperature sensor is being used the unit should be placed where the temperature is representative of the general room conditions.

Cold or warm air draughts; radiant heat and direct sunlight should be avoided.

The standard height to install this unit is 1.5 meter (5 feet) from the floor.

### Installation procedure:

1. Disconnect power to the unit.
2. Connect the wires as shown in the enclosed wiring diagram.  
All terminals accept 1x0.5mm<sup>2</sup>/24 AWG.
3. If needed, change DIP switches position.
4. Install the panel in the electrical box (Gewiss Box - GW 24 203).
5. Tighten up the 2 screws.
6. Adapt the front frame-panel into its place, by pushing it towards the wall.

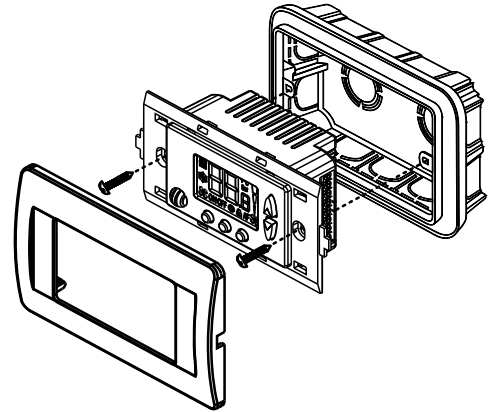

*Risk of Electric Shock and Property Damage. Disconnect each of multiple power supplies before making electrical connections. Contact with components carrying hazardous voltage can cause electric shock and may result in severe personal injury or death.*



*The integrated circuits in the controller are sensitive to static currents. Take suitable precautions.*



## 3. Wiring connections

**Important! Use only TS05 or TS06 sensors**

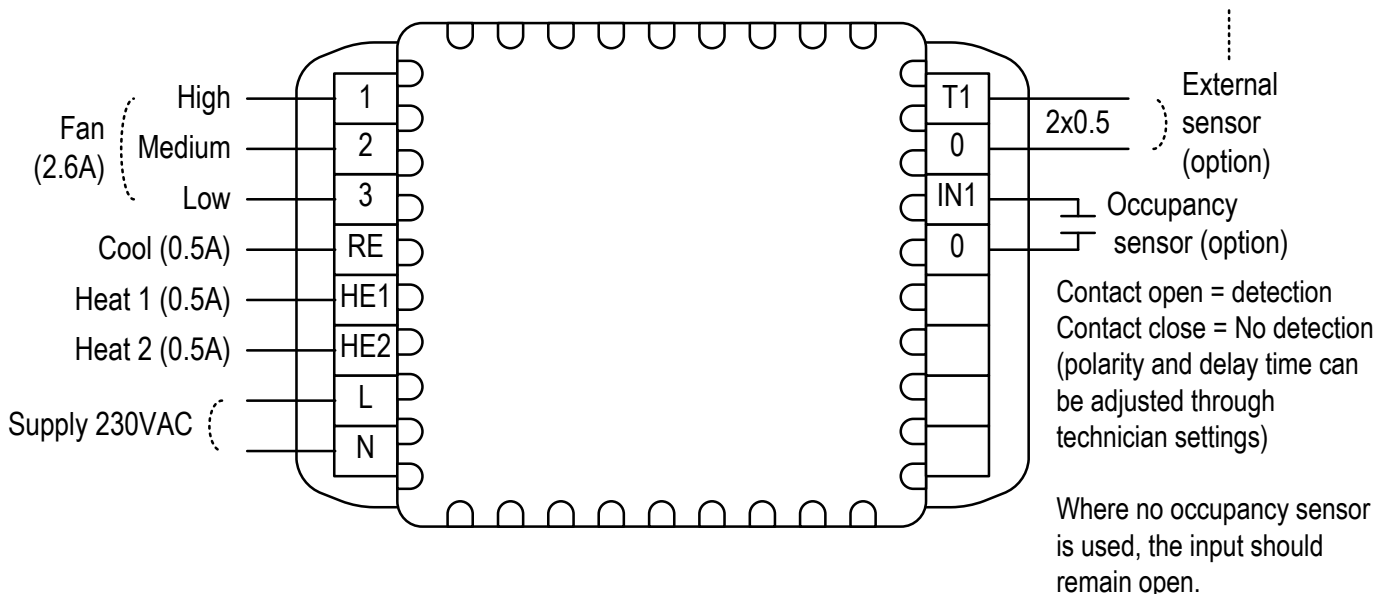

#### 4. DIP switch configuration

**IMPORTANT!** Before making any changes in the DIP switch disconnect power from the unit.

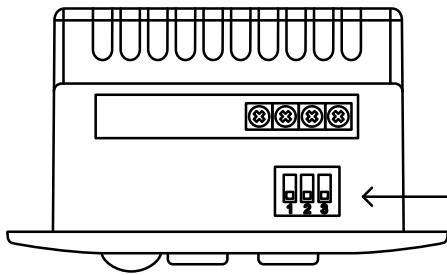

The DIP switch is located on the side of the thermostat, next to the T1,0 and IN1,0 terminals.

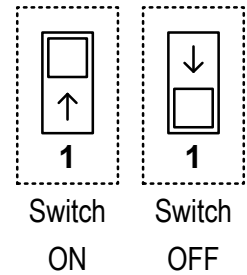

	ON	OFF	Default
S1	Enable Auto mode	Disable Auto mode	OFF
S2	Display set-point only	Normal temperature display	OFF
S3	30 seconds fan off delay in heating	No fan delay	OFF

\*The option to always run fan on demand must be used in no valve system.

#### 5. External temperature sensor connection (T1)

**Important** – Use only an approved NTC 50K@25°C external sensor with the following characteristics.

N.T.C. Sensor; Temperature ~ Resistance Characteristics

Temp °C	7.2	10.0	12.8	15.6	18.3	21.1	23.9	26.7	29.4	32.2
Res. KΩ	115.8	100.9	88.1	77.1	67.7	59.6	52.5	46.4	41.2	36.6

##### T1 - External (Return air) sensor connection – option

- Disconnect power and connect the temperature sensor to the unit.
- Reconnect power.
- Change technician parameter 6.9 to “E” (external sensor).
- Check the temperature readings and if needed use technician parameter 6.4 to adjust the offset for calibration of ambient temperature.

Note: The length of the sensors cable is 100 feet (30 meters) with standard cable.

If longer distance is needed then the cable **MUST** be shielded.

## 6. Technician settings

### Enter technician settings

- Adjust the set point temperature to 10°C/50°F and wait until display stops flashing.
- Press and hold the [Mode] button (8 sec.) to enter technician settings.
- Press the [Mode] button to proceed to the next parameter.
- Press the [Fan] button to return to the previous parameter.
- Use the [+] and [-] buttons to select/adjust parameter values.
- Press the [On/Off] button or wait 30 seconds to exit technician settings and return to normal display.



### 6.1 Set point temperature limit for heat

- Range: 10...30°C/50...86°F, default 30°C/86°F.



### 6.2 Set point temperature limit for cool

- Range: 10...30°C/50...86°F  
Default 10°C/50°F.



### 6.3 Lock buttons

- "OP" - Open (enable all buttons).
- "LO" - Lock all buttons except [+] and [-].



### 6.4 Offset for calibration of temperature reading

- Range: (-6)...(+6)°C/(-9.8)...(+9.8)°F  
Default 0°C/0°F.



### 6.5 Enable or disable the LCD backlight

- On – The backlight is enabled.
- Off – The backlight is disabled.



### 6.6 Enable or disable Auto speed selection

- On – Enable the selection of auto speed.
- Off – Disable the selection of auto speed.

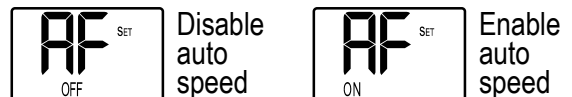

### 6.7 Select On/Off or Start/Stop configuration

- On – Start/Stop (remains off after power outage)
- Off – On/Off (returns to previous state after power outage).

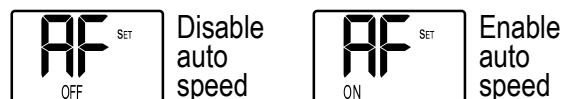

## 6. Technician settings (cont.)

### 6.8 Fan on demand configuration (Auto fan)

- On – The fan will run as long as the unit is ON.
- Off – In Cooling, the fan will run as long as the unit is ON. In Heating, the fan will run only with demand for heating.



Auto fan disabled



Auto fan enabled

### 6.9 Internal or External sensor

- “I” – Internal sensor.
- “E” – External sensor connected to T1,0 terminals.

Note: When external sensor is selected but not connected, the display will show -9.8°C/-9.8°F.



External sensor



Internal sensor

### 6.10 Occupancy sensor logic

- “SO” - Occupancy sensor enabled (default).
- “SF” - Occupancy sensor disabled.



Occupancy sensor enabled



Occupancy sensor disabled

### 6.11 Occupancy sensor polarity

- “SO” - Normally open – contact open on detection (default)
- “SF” - Normally close – contact closed on detection



Normally open



Normally close

### 6.12 Occupancy sensor off delay

- Range: 0...60 minutes.
- Select 0 for no delay (default).



Occupancy sensor Off delay

### 6.13 Action when returning to occupied mod

- “F0” - Relays off when unoccupied and back on when reoccupied (default).
- “F1” - Thermostat turns off when unoccupied and remains off when reoccupied.



Return to previous state



Remains Off

### 6.14 Resolution of temperature display

- “S0.5” - Resolution of 0.5°C (default).
- “S1.0” - Resolution of 1.0°C.



Resolution of 0.5°C



Resolution of 1.0°C

Press the [Mode] button again or wait 30 seconds to exit technician settings and return to normal display.